



## Novakon Panel PC – NPP Series



### **NPP-156P02**

Fanless Industrial Modular Panel PC  
Intel® Alder Lake-N Processor N97

## User Manual

P/N:1306.0034 V1.0

Release Date: August, 2024

©2024 Copyrights Reserved



## Warning!

This equipment generates, uses and can radiate radio frequency energy and if not installed and used in accordance with the instruction manual, it may cause interference to radio communications. It has been tested and found to comply with the limits for a Class A computing device pursuant to FCC Rules, which are designed to provide reasonable protection against such interference when operated in a commercial environment. Operation of this equipment in a residential area is likely to cause interference in which case the user at his own expense will be required to take whatever measures may be required to correct the interference.

Electric Shock Hazard – Do not operate the machine with its back cover removed. There are dangerous high voltages inside.

## Caution

Risk of explosion if the battery is replaced with an incorrect type. Batteries should be recycled where possible. Disposal of used batteries must be in accordance with local environmental regulations.

## Safety Precautions

Follow the messages below to prevent your systems from damage:

- ◆ Avoid your system from static electricity on all occasions.
- ◆ Prevent electric shock. Do not touch any components of this card when the card is power-on. Always disconnect power when the system is not in use.
- ◆ Disconnect power when you change any hardware devices. For instance, when you connect a jumper or install any cards, a surge of power may damage the electronic components or the whole system.

# Table of Contents

Warning!.....	1
Caution .....	1
Safety Precautions .....	1
<b>Chapter 1 Getting Started .....</b>	<b>3</b>
1.1 Features .....	3
1.2 Specifications .....	3
1.3 Dimensions .....	5
1.4 Brief Description of NPP-156P02 .....	6
1.5 DC-IN Power Connector.....	6
1.7 COM1,COM2 Port Pin Define .....	7
1.8 Installation of Rubber Seal .....	8
1.9 VESA Mounting.....	9
1.10 Panel Mounting .....	9
<b>Chapter 2 Hardware .....</b>	<b>10</b>
2.1 Motherboard Introduction .....	10
2.2 Specifications .....	10
2.3 Jumpers and Connectors Location.....	12
2.4 Jumpers Setting and Connectors .....	13
<b>Chapter 3 BIOS Setup .....</b>	<b>20</b>
3.1 Introduction .....	20
3.2 The Menu Bar .....	21
3.2.1 Main.....	22
3.2.2 Advanced.....	23
3.2.3 Boot .....	30
3.2.4 Security.....	30
3.2.5 Chipset .....	31
3.2.6 Power .....	32
3.2.7 Save & Exit.....	33

# **Chapter 1 Getting Started**

## **1.1 Features**

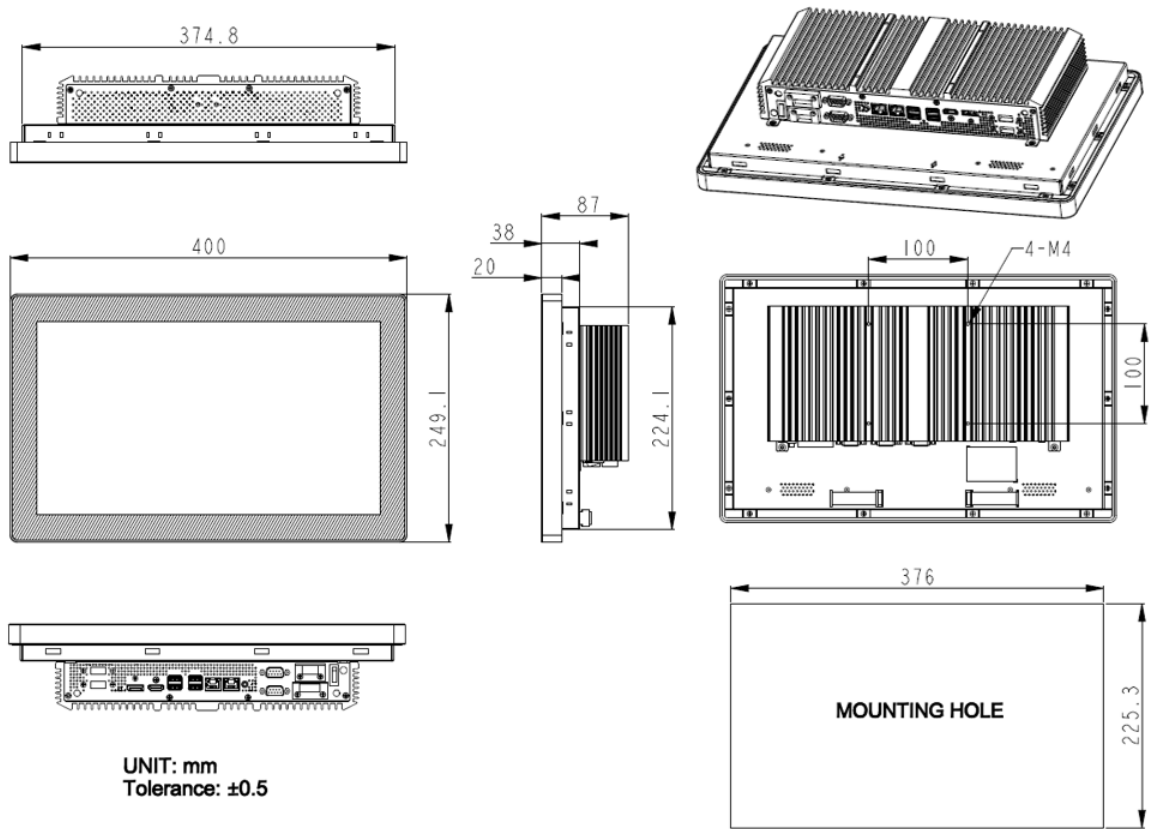
- 15.6" Industrial Compact Size Panel PC
- Flat front panel touch screen
- Fanless design
- Intel® Alder Lake-N Processor N97 (2.0 GHz) CPU
- DC 9~36V wide-ranging power input
- IP66 compliant front panel
- Projected capacitive touchscreen support 7H anti-scratch surface

## **1.2 Specifications**

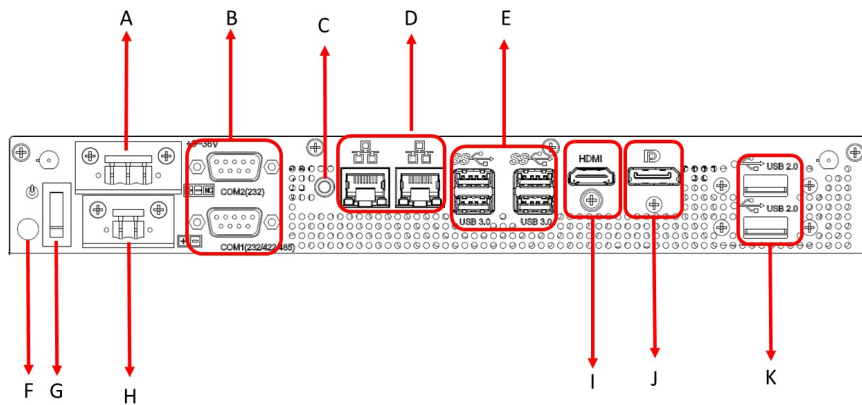
<b>NPP-156P02</b>	
<b>LCD</b>	
LCD Size	15.6 inches TFT-LCD
Touch Type	Projected Capacitive Touch
Luminance (cd/m <sup>2</sup> )	350 (Typical)
<b>System</b>	
CPU	Onboard Intel Alder Lake-N Processor N97 2.0GHz
Chipset	SoC
Memory	1 x SO-DIMM, DDR5 4800MHz (16GB Optional)
<b>I/O Port</b>	
USB	2 x USB 3.2 Gen 2, 2 x USB 3.2 Gen 1, 2 x USB 2.0 (Optional)
Serial	1 x DB9 (RS-232/422/485 & RI/5V/12V) 1 x DB9 (RS-232)
Audio	1 x Audio Line Out
LAN	2 x 2.5 GbE LAN RJ-45
HDMI	1 x HDMI 2.0
Display Port	1
Power	1 x 2 pins terminal block for external power switch (Optional) 1 x 3 pins terminal block power connector 1 x power switch on/off
<b>Storage Space</b>	
Storage (SSD)	1 x 2280 M.2 B key (SATA/PCIe x1)

<b>Expansion</b>	
Expansion Slot	1 x M.2 E key (PCIe x1, USB 2.0), 2230
<b>Touch Screen – Projected Capacitive Type</b>	
TS Control IC	Chip On Board
Interface	USB
Light Transmission	Over 84%
<b>Power</b>	
Power Input	DC 9~36V
<b>Mechanical</b>	
Color	Silver (Pantone 877C)
Front Bezel Metal	Aluminum front bezel/ Steel for back cover
IP Rating	IP66 compliant front panel
<b>Environmental</b>	
Operating temperature	0~50°C
Storage temperature	-20~60°C
Humidity	10 to 90% @ 40°C, non- condensing
Certification	CE / FCC Class A
<b>Operating System Support</b>	
OS Support	Windows 10 IoT, Debian 11

### 1.3 Dimensions



**Figure 1.1: Dimensions of NPP-156P02**



- A. DC-IN (DC+9V~36V)
- B. COM1 & COM2
- C. Audio Line Out
- D. LAN1 & 2
- E. USB 3.2 x4
- F. Power LED (Green)
- G. Power Switch
- H. Remote Power Switch
- I. HDMI
- J. Display Port
- K. USB 2.0 x2

**Figure 1.2: Rear I/O Port Placement**

## 1.4 Brief Description of NPP-156P02

This is a 15.6" Industrial Compact Size Panel PC, which comes with flat front panel touch screen and fanless design. It is powered by Intel Alder Lake-N Processor N97 (2.0 GHz) processor; and 8GB DDR5 4800MHz memory (16GB memory is for option). NPP-156P02 is DC 9~36V wide-ranging power input and IP66 compliant front panel. The model features projected capacitive touch supports 7H anti-scratch surface is ideal for use as PC-based controller for industrial automation & factory automation.

## 1.5 DC-IN Power Connector

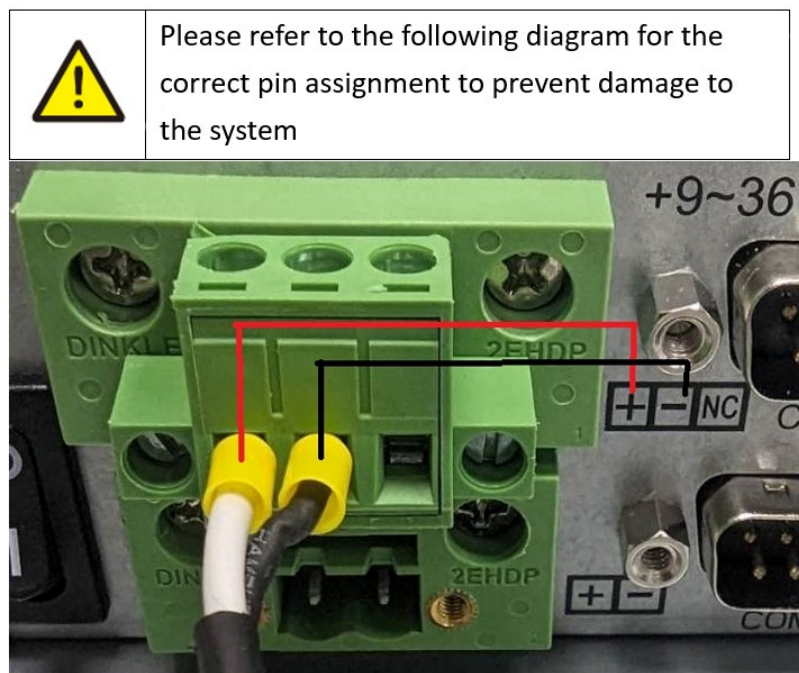
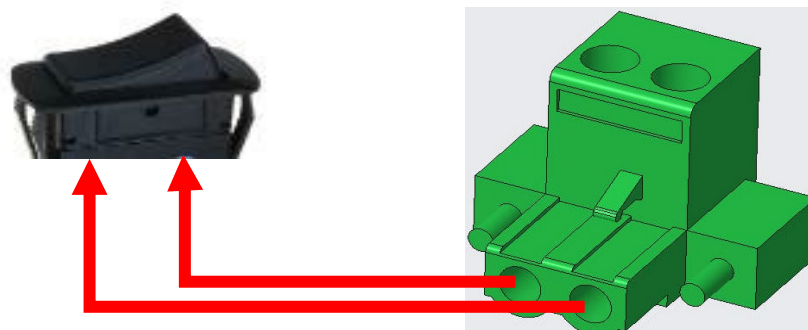


Figure 1.3: Power IN Cable & Connector Location

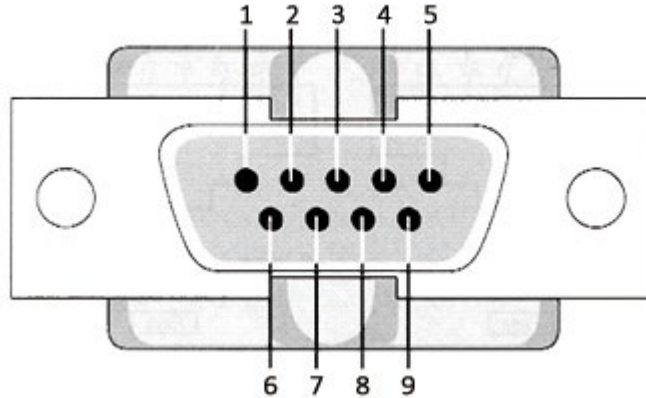
## 1.6 Remote Power Switch

Link the Remote Power Switch connector to the switch lines



**Figure 1.4: Power Switch Link Cable & Connector Layout**

### 1.7 COM1,COM2 Port Pin Define



**COM1**

- Supports RS-232/422/485

**COM2**

- Supports RS-232

RS232		
PIN	SIGNAL	DESCRIPTION
1	NDCD	Data Carrier Detect
2	NSIN	Signal In
3	NSOUT	Signal Out
4	NDTR	Data Terminal Ready
5	GND	Signal Ground
6	NDSR	Data Set Ready
7	NRTS	Request To Send
8	NCTS	Clear To Send
9	VCC_COM/ NC	VCC_COM/ No Connection
10	No Pin	No Pin

RS422		
PIN	SIGNAL	DESCRIPTION
1	422 TXD-	Transmit Data, Negative
2	422 TXD+	Receive Data, Positive
3	422 RXD+	Transmit Data, Positive
4	422 RXD-	Receive Data, Negative
5	GND	Signal Ground
6	NC	No Connection
7	NC	No Connection
8	NC	No Connection
9	NC	No Connection
10	NC	No Connection

RS485		
PIN	SIGNAL	DESCRIPTION
1	TXD-	Transmit Data, Negative
2	TXD+	Transmit Data, Positive
3	NC	No Connection
4	NC	No Connection
5	GND	Signal Ground
6	NC	No Connection
7	NC	No Connection
8	NC	No Connection
9	NC	No Connection
10	NC	No Connection



## 1.8 Installation of Rubber Seal

### Step 1

Start installing Rubber Seal from the bottom center point of the NPP-156. (The position of the arrow in the picture.)



### Step 2

Insert into the groove according to the frame.



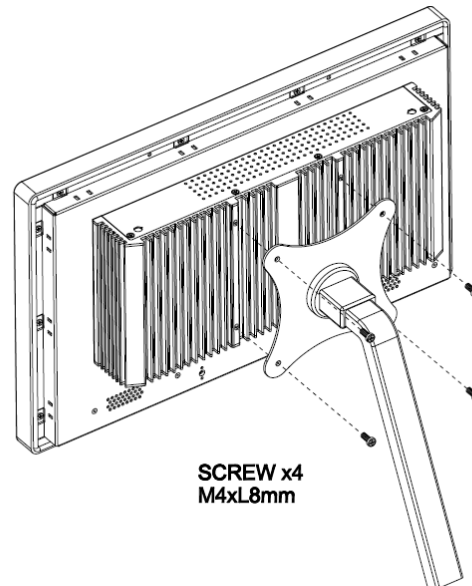
### Step 3

After installation, if there is excess Rubber Seal, you can use scissors to cut off the excess length.



## 1.9 VESA Mounting

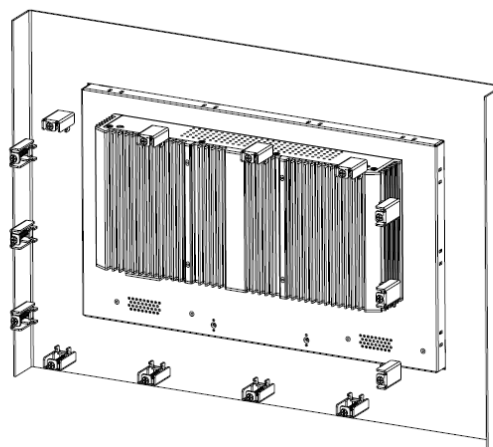
The NPP-156P02 is designed to be VESA mounted as shown in Picture. Just carefully place the unit through the hole and tighten the given screws from the rear to secure the mounting.



**Figure 1.5: VESA Mounting**

## 1.10 Panel Mounting

There are ten holes located along the four sides of NPP-156P02. Insert the clamp from the four sides and tighten them with the nuts provided.



**Figure 1.6: Panel Mounting**

## Chapter 2 Hardware

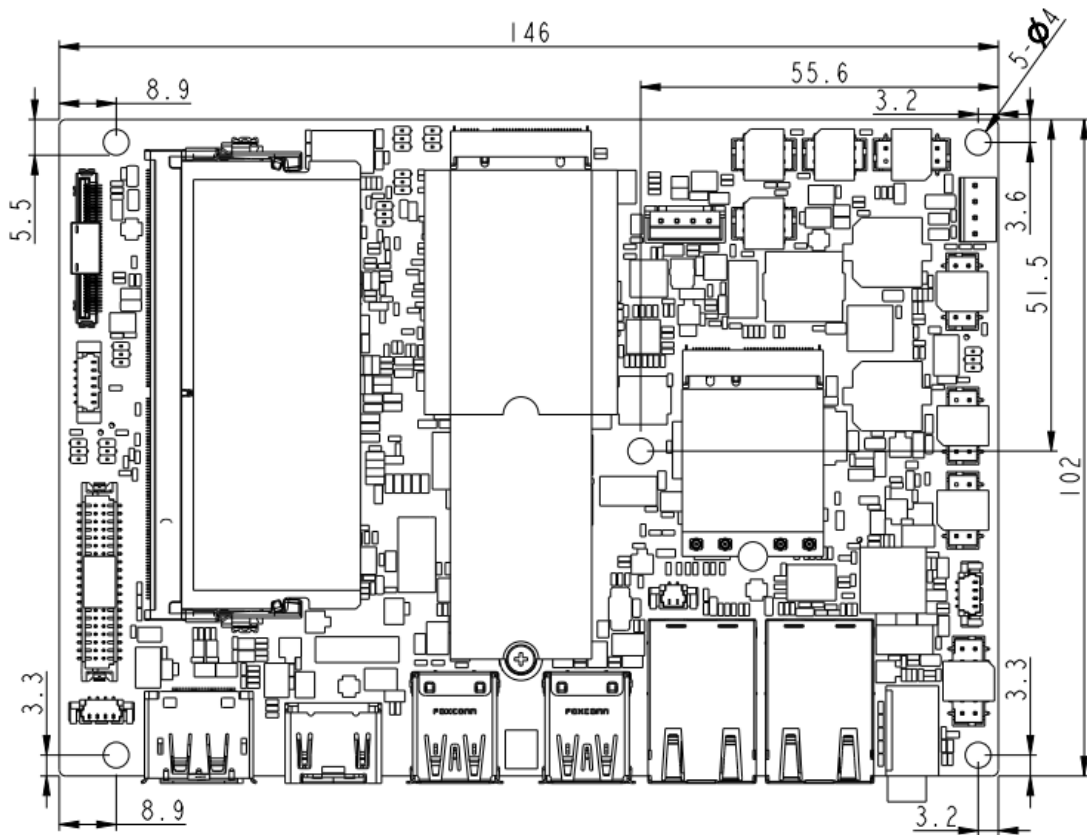
### 2.1 Motherboard Introduction

A 3.5" industrial motherboard developed on the basis of Intel Alder Lake N-series Processors, which provides abundant peripheral interfaces to meet the needs of different customers. Also, it features dual 2.5 GbE ports, 2-COM ports, ten USB ports, one HDMI port, one Display Port and one LVDS interface. To satisfy the special needs of high-end customers. The product is widely used in various sectors of industrial control.

### 2.2 Specifications

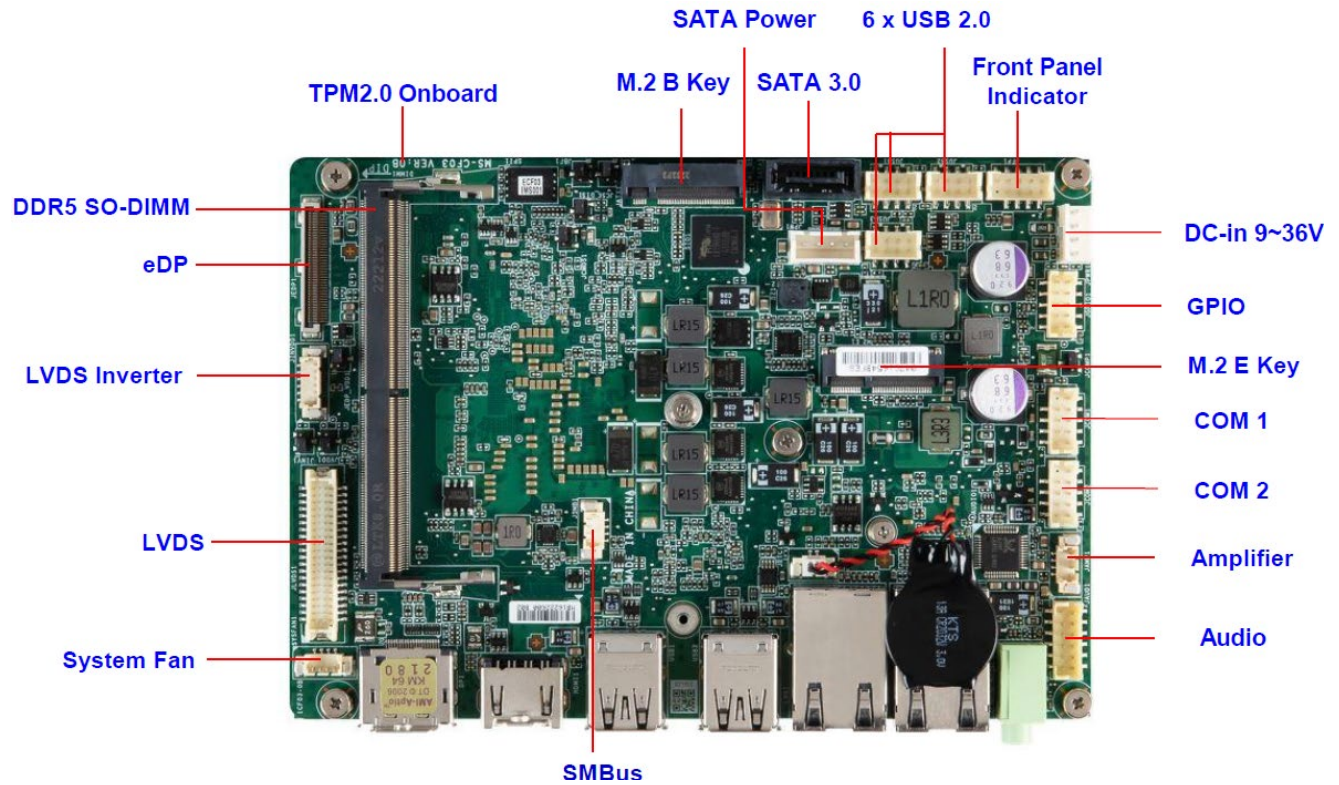
Specifications	
<b>Board Size</b>	146mm x 101.7mm
<b>CPU Support</b>	Onboard Intel® Alder Lake-N Processor N97 2.0GHz, quad-core, 4 threads, (up to 3.6GHz)
<b>Chipset</b>	SoC
<b>BIOS</b>	AMI/UEFI
<b>Memory Support</b>	1 x SO-DIMM, DDR5 4800MHz, up to 16GB
<b>Graphics</b>	Intel® UHD Graphics 1.25 GHz
<b>Display Mode</b>	1 x HDMI Port, 1 x Display Port 1 x LVDS (18/24-bit dual LVDS)
<b>Support Resolution</b>	Up to 3840 x 2160 for HDMI, Up to 4096 x 2304 for DP, Up to 1920 x 1200 for LVDS
<b>Triple Display</b>	1 x HDMI + 1 x DP + LVDS
<b>Storage</b>	1 x SATA 3.0
<b>Ethernet</b>	2 x 2.5 GbE LAN Ports (Intel® I255-V)
<b>USB</b>	2 x USB 3.2 Gen 1 & 2 x USB 3.2 Gen 2 External I/O port 6 x USB 2.0 Pin headers
<b>Serial</b>	1 x COM header (RS-232/422/485 & 0V/5V/12V) (COM1) 1 x COM header (RS-232) (COM2)
<b>Digital I/O</b>	8-bit (4 x GPI; 4 x GPO), 5V
<b>Battery</b>	Support CR2032 battery by 2-pin wafer header
<b>Audio</b>	Realtek® ALC897 HD Audio Codec (Co-lay ALC888-VD2-GR)
<b>Expansion Slots</b>	1 x M.2 B key (SATA/PCIe x1), 2242/3042/2280

	1 x M.2 E key (PCIe x1, USB 2.0), 2230
<b>Power Management</b>	Wide Range DC9V~36V input 1 x 4-pin power input connector (CN2)
<b>Switches and LED Indicators</b>	Front panel header 1 x Power on/off switch 1 x Reset 1 x Power LED status 1 x HDD LED status
<b>External I/O port</b>	1 x Headphone Jack 1 x HDMI 1 x Display Port 2 x RJ45 LAN Ports 2 x USB 3.2 Gen 1 2 x USB 3.2 Gen 2
<b>Temperature</b>	Operating: -10°C to 60°C Storage: -20°C to 80°C
<b>Humidity</b>	0% - 90%, non-condensing, operating
<b>EMI/EMS</b>	CE, FCC Class B, BSMI, VCCI, RCM, UKCA

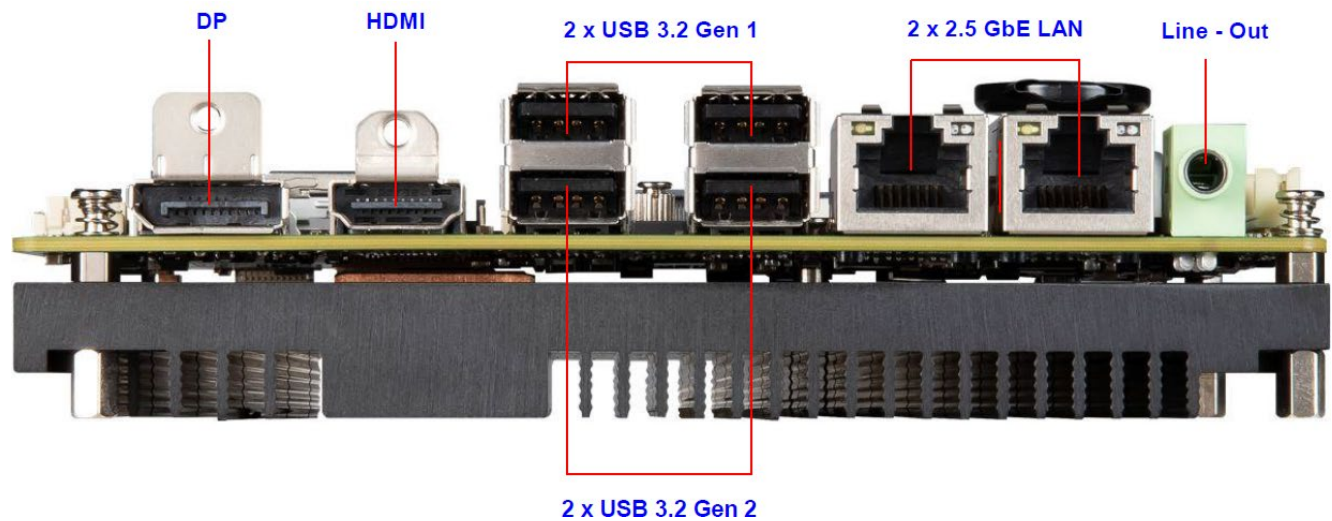


**Figure 2.1: Motherboard Dimensions**

## 2.3 Jumpers and Connectors Location



**Figure 2.2: Connectors Location-Bottom Board**



**Figure 2.3: Connectors Location-Top Board**

## 2.4 Jumpers Setting and Connectors

### 1. U1:

(FCBGA1170), onboard Intel Alder Lake-N Core i3-N305 & N97 Processors.

Model	Processor			
	PBF	Cores/Threads	TDP	Remarks
N97	2.0 up to 3.6GHz	4 / 4	12W	option

### 2. Dimm1:

SO-DIMM DDR5 Memory.

Model	Memory
N97	16GB (Max)

### 3. BAT1:

(1.25mm Pitch 1x2 Wafer Pin Header) 3.0V Li battery is embedded to provide power for CMOS.

Pin#	Signal Name
1	VBAT
2	Ground

### 4. DC\_IN1:

(5.08mm Pitch 1x3 Pin Connector), DC9~36V System power input connector.

Pin#	Power Input
1	DC+9V~36V
2	Ground
3	FG

### 5. DC\_IN (option):

(2.54mm Pitch 1x4 wafer Pin Header) DC12V System power input connector.

Pin#	Signal Name
1	VCC_BAT (DC+12V input)
2	VCC_BAT (DC+12V input)
3	Ground
4	Ground

## 6. BT1/BT2/P\_SW (option):

**Power on/off button**, use to connect power switch button. The two pins are disconnected under normal condition. You may short them temporarily to realize system startup & shutdown or awaken the system from sleep state.

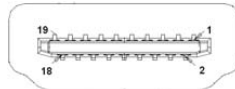
## 7. System FAN:

(1.25mm Pitch 1x4 Pin Header), Fan connector, cooling fans can be connected directly for use. You may set the rotation condition of cooling fan in menu of BIOS CMOS Setup.

Pin#	Signal Name
1	Ground
2	FAN_VCC
3	FAN_Sense
4	FAN_PWM

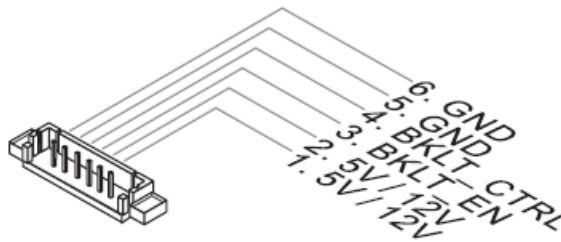
## 8. HDMI1:

(HDMI 19P Connector), High Definition Multimedia Interface connector.



## 9. LVDS Inverter:

(1.25mm Pitch 1x6 wafer Pin Header), Backlight control connector for LVDS.



Pin#	Signal Name
1	+DC12V
2	+DC12V
3	Ground
4	Ground
5	BKLT_EN_OUT
6	BKLT_CTRL

## 10. JLVDS1 :

(1.25mm Pitch 2x20 Connector, DF13-40P), for 18/24-bit LVDS output connector, fully supported by Parad PS8625(DP to LVDS), the interface features dual channel 24-bit output. Low Voltage Differential Signaling, A high speed, low power data transmission standard used for display connections to LCD panels.

	1	12V	2	12V
	3	LCD_VDD	4	12V
	5	LCD_VDD	6	LCD_VDD
	7	DDC_CLK	8	DDC_DATA
	9	L_BKLT_CTRL#	10	LCDEN
	11	INV_ON	12	LVDS_DETECT#_C
	13	LVDSA_DATA1	14	LVDSA_DATA0
	15	LVDSA_DATA#1	16	LVDSA_DATA#0
	17	GND	18	GND
	19	LVDSA_DATA3	20	LVDSA_DATA2
	21	LVDSA_DATA#3	22	LVDSA_DATA#2
	23	GND	24	GND
	25	LVDSB_DATA1	26	LVDSB_DATA0
	27	LVDSB_DATA#1	28	LVDSB_DATA#0
	29	GND	30	GND
	31	LVDSB_DATA3	32	LVDSB_DATA2
	33	LVDSB_DATA#3	34	LVDSB_DATA#2
	35	GND	36	GND
	37	LVDSB_CLK	38	LVDSA_CLK
	39	LVDSB_CLK#	40	LVDSA_CLK#

## 11. JCOMP1:

(1.0mm Pitch 1x3 Pin Header), COM1 jumper setting, Pin 1~3 are used to select signal out of pin 9 of COM1 port.

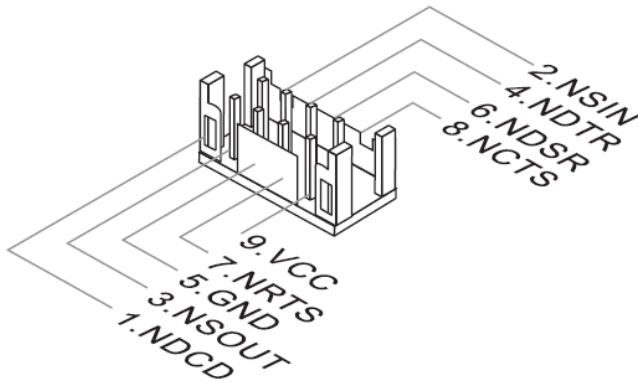
JP1 Pin#	Function
Close 1-2	COM1 Pin9: DC+5V <b>(default)</b>
Close 2-3	COM1 Pin9: DC+12V (option)



## 12. COM1:

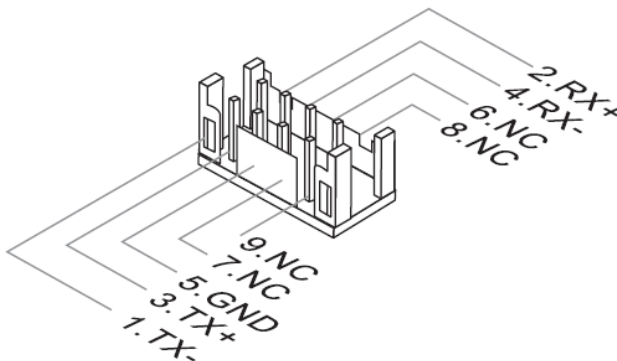
(Type Wafer), Rear serial port, standard DB9 Male serial port is provided to make a direct connection to serial devices. COM1 port is controlled by pins No.1~3 of JP1, select output Signal RI or 5V or 12V for details, please refer to description of JP1 and S\_232 and S\_422 setting.

### RS232



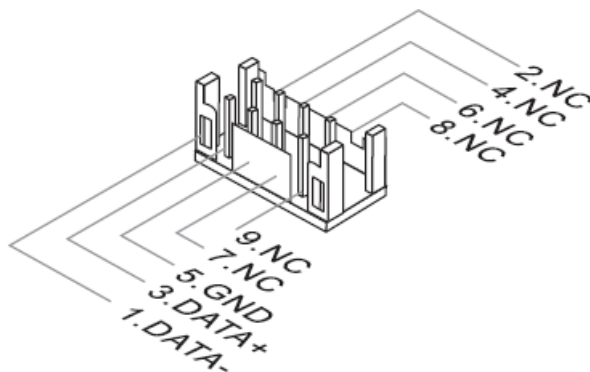
PIN	SIGNAL	DESCRIPTION
1	NDCD	Data Carrier Detect
2	NSIN	Signal In
3	NSOUT	Signal Out
4	NDTR	Data Terminal Ready
5	GND	Signal Ground
6	NDSR	Data Set Ready
7	NRTS	Request To Send
8	NCTS	Clear To Send
9	VCC	5V or 12V selected by jumper
10	NC	No Connection

### RS422



PIN	SIGNAL	DESCRIPTION
1	422 TXD-	Transmit Data, Negative
2	422 RXD+	Receive Data, Positive
3	422 TXD+	Transmit Data, Positive
4	422 RXD-	Receive Data, Negative
5	GND	Signal Ground
6	NC	No Connection
7	NC	No Connection
8	NC	No Connection
9	NC	No Connection
10	NC	No Connection

### RS485

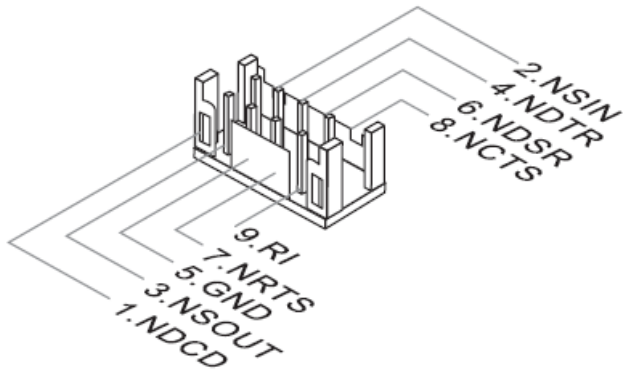


PIN	SIGNAL	DESCRIPTION
1	485 TXD-	Transmit Data, Negative
2	NC	No Connection
3	485 TXD+	Transmit Data, Positive
4	NC	No Connection
5	GND	Signal Ground
6	NC	No Connection
7	NC	No Connection
8	NC	No Connection
9	NC	No Connection
10	NC	No Connection

### 13. COM2:

(Type Wafer), Rear serial port, standard DB9 Male serial port is provided to make a direct connection to serial devices.

### RS232



PIN	SIGNAL	DESCRIPTION
1	NDCD	Data Carrier Detect
2	NSIN	Signal In
3	NSOUT	Signal Out
4	NDTR	Data Terminal Ready
5	GND	Signal Ground
6	NDSR	Data Set Ready
7	NRTS	Request To Send
8	NCTS	Clear To Send
9	RI	Ring Indicator
10	NC	No Connection

### 14. LED1 (option):

LED1: LED STATUS. Green LED for Power Good status.

### 15. SATA\_Power:

(2.5mm Pitch 1x2 box Pin Header), One onboard 5V output connector is reserved to provide power for SATA devices.

Pin#	Signal Name
1	Vcc5V
2	Ground
3	Ground
4	Vcc12V

### 16. SATA1:

(SATA 7Pin+15Pin), SATA Connectors one SATA connector is provided with transfer speed up to 3.0Gb/s.

### 17. M2\_E1: M.2 Slot (E Key, 2230)

Please install the Wi-Fi/ Bluetooth card into the M.2 slot.

### 18. M2\_B1: M.2 Slot (B Key, 2242, 3042, 2280)

Please install the module card into the M.2 slot

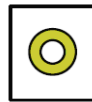
## 19. AUDIO:

(2.0mm Pitch 2X6 Pin Header), Front Audio, An onboard Realtek ALC662-VD codec is used to provide high-quality audio I/O ports. Line Out can be connected to a headphone or amplifier. Line In is used for the connection of external audio source via a Line in cable. MIC is the port for microphone input audio.

Signal Name	Pin#	Pin#	Signal Name
LINE-IN-R	1	2	MIC-IN-R
LINE-IN-L	3	4	MIC-IN-L
LINE-OUT-R	5	6	MIC-IN_JD
LINE-OUT-L	7	8	LINE-IN_JD
FRONT_JD	9	10	GND-AUD
GND-AUD	11	12	GND-AUD

## 20. LINE\_OUT:

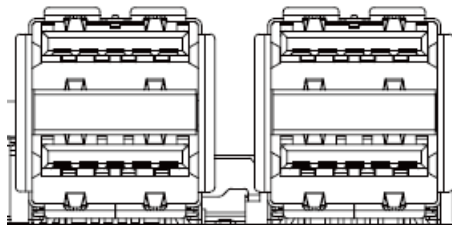
(Diameter 3.5mm Jack), HD Audio port, an onboard Realtek **ALC662-VD** codec is used to provide high quality audio I/O ports. Line Out can be connected to a headphone or amplifier.



Line out

## 21. 4 x USB3.2 Gen1&2:

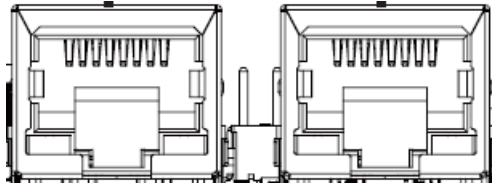
**USB0/USB2:** (Double stack USB type A), Rear USB connector, it provides up to two USB3.0 ports, one USB 2.0 port, support USB full-speed and low-speed signaling.



**Each USB Type A Receptacle (2 Ports) Current limited value is 2.0A, If the external USB device current exceeds 2.0A, please separate connectors into different Receptacle.**

## 22. 2.5GbE RJ-45 LAN Jack:

**LAN1/LAN2:** (RJ45 Connector), Rear LAN port, two standard 10/100/1000M/25000M RJ-45 Ethernet ports are provided. Use Intel 82574L chipset, LINK LED (green) and ACTIVE LED (yellow) respectively located at the left-hand and right-hand side of the Ethernet port indicate the activity and transmission state of LAN.



## 23. BUZ1:

Onboard buzzer

## 24. JGPIO1(option):

(2.0mm Pitch 1X10 Pin Header)For expand connector, it provides eight GPIO.

	1	GND	2	VCC5
	3	GP00	4	GPI0
	5	GP01	6	GPI1
	7	GP02	8	GPI2
	9	GP03	10	GPI3

# Chapter 3 BIOS Setup

## 3.1 Introduction

BIOS (Basic input/output system) provides hardware detailed information and boot-up options, which include firmware to control, set-up and test all hardware settings. Therefore, BIOS is the communication bridge between OS/application software and hardware.

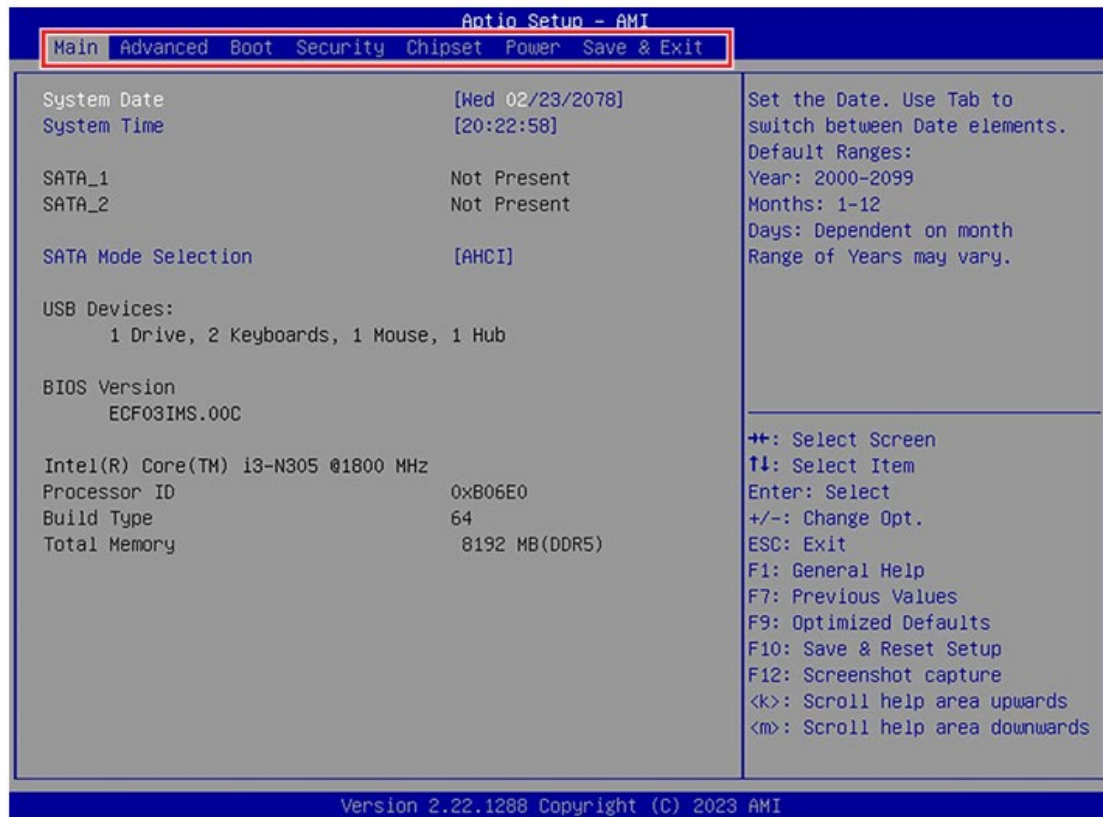
### 3.1.1 How to Entering into BIOS menu

Once the system is power on, press the <DEL> or <F2> key to enter BIOS Setup, <F11> key to Boot Menu, <F12> key to PXE Boot.

### 3.1.2 Function Keys to setup in BIOS Setup program

← →	Select Screen
↑ ↓	Select Item
Enter	Select
+ -	Change Value
Esc	Exit
F1	General Help
F7	Previous Values
F9	Optimized Defaults
F10	Save & Reset*
F12	Screenshot capture
<K>	Scroll help area upwards
<M>	Scroll help area downwards

## 3.2 The Menu Bar



### ► Main

Use this menu for basic system configurations, such as time, date, etc.

### ► Advanced

Use this menu to set up the items of special enhanced features.

### ► Boot

Use this menu to specify the priority of boot devices.

### ► Security

Use this menu to set supervisor and user passwords.

### ► Chipset

This menu controls the advanced features of the on-board chipsets.

### ► Power

Use this menu to specify your settings for power management.

### ► Save & Exit

This menu allows you to load the BIOS default values or factory default settings into the BIOS and exit the BIOS setup utility with or without changes.

## 3.2.1 Main

The screenshot shows the 'Aptio Setup - AMI' BIOS interface. The 'Main' tab is selected. The following table represents the visible settings:

System Date	[Wed 02/23/2078]	Set the Date. Use Tab to switch between Date elements. Default Ranges: Year: 2000-2099 Months: 1-12 Days: Dependent on month Range of Years may vary.
System Time	[20:22:58]	
SATA_1	Not Present	
SATA_2	Not Present	
SATA Mode Selection	[AHCI]	
USB Devices:	1 Drive, 2 Keyboards, 1 Mouse, 1 Hub	
BIOS Version	ECF03IMS.00C	
Intel(R) Core(TM) i3-N305 @1800 MHz		
Processor ID	0xB06E0	
Build Type	64	
Total Memory	8192 MB(DDR5)	

**HDD Information**

- **RAID (VMD) Disabled:** Display HDD information as plugging in status.
- **RAID (VMD) Enabled:** Display "Empty" only.

\*SATA\_2 is for M.2 B key [SATA signal]

### ► System Date

This setting allows you to set the system date. Use <Tab> key to switch between date elements.

Format: <Day> <Month> <Date> <Year>.

### ► System Time

This setting allows you to set the system time. Use <Tab> key to switch between time elements.

Format: <Hour> <Minute> <Second>.

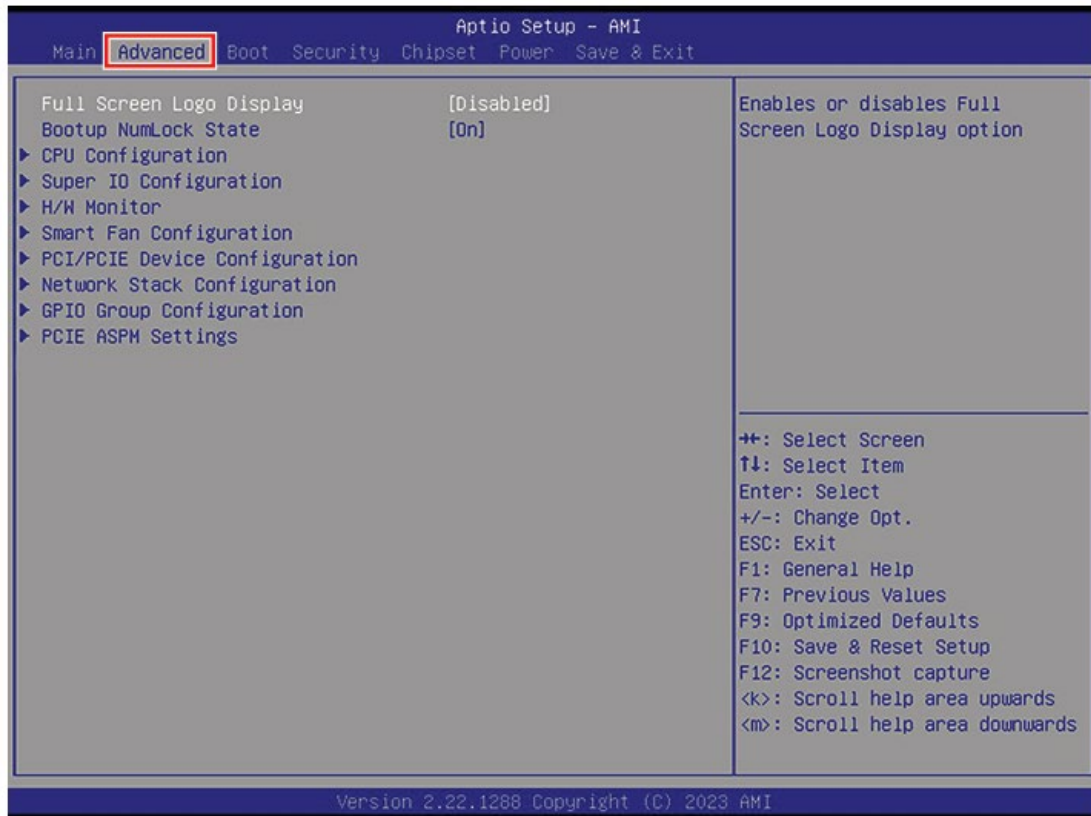
### ► SATA Mode Selection

This setting specifies SATA controller mode.

[AHCI] AHCI (Advanced Host Controller Interface), is a technical standard for an interface that allows the software to communicate with Serial ATA (SATA) devices. It offers advanced SATA features such as Native Command Queuing (NCQ) and hot-plugging.

[RAID] RAID (Redundant Array of Independent Disks) is a virtual disk storage technology that combines multiple physical disks into one unit for data redundancy, performance improvement, or both.

## 3.2.2 Advanced



### ► Full Screen Logo Display

This BIOS feature determines if the BIOS should hide the normal POST messages with the motherboard or system manufacturer's full-screen logo.

[Enabled] BIOS will display the full-screen logo during the boot-up sequence, hiding normal POST messages.

[Disabled] BIOS will display the normal POST messages, instead of the full-screen logo.

Please note that enabling this BIOS feature often adds 2-3 seconds to the booting sequence. This delay ensures that the logo is displayed for a sufficient amount of time. Therefore, **it is recommended to disable this BIOS feature for faster boot-up.**

### ► Bootup NumLock State

This setting is to set the state of the Num Lock key on the keyboard when the system is powered on.

[On] Turn on the Num Lock key when the system is powered on.

[Off] Allow users to use the arrow keys on the numeric keypad.



## ► CPU Configuration

Advanced	
CPU Configuration	
Intel(R) Core(TM) i3-N305	
Processor ID	0xB06E0
Processor Speed	1800 MHz
E-core Information	
L1 Data Cache	32 KB x 8
L1 Instruction Cache	64 KB x 8
L2 Cache	2048 KB x 2
L3 Cache	6 MB
Intel Virtualization Technology	[Enabled]
Active Efficient-cores	[All]
Intel(R) SpeedStep(tm)	[Enabled]
Intel(R) Speed Shift Technology	[Enabled]
C states	[Enabled]
When enabled, a VMM can utilize the additional hardware capabilities provided by Vanderpool Technology.	
⇧⇧: Select Screen ↑↓: Select Item Enter: Select +/-: Change Opt. ESC: Exit F1: General Help F7: Previous Values F9: Optimized Defaults F10: Save & Reset Setup F12: Screenshot capture <k>: Scroll help area upwards <m>: Scroll help area downwards	

### ► Intel Virtualization Technology

Enables or disables Intel Virtualization technology.

[Enabled] Enables Intel Virtualization technology and allows a platform to run multiple operating systems in independent partitions. The system can function as multiple systems virtually.

[Disabled] Disables this function.

### ► Active Efficient-cores

Select the number of active Efficient-cores (E-cores).

### ► Intel(R) SpeedStep(TM)

Enhanced Intel SpeedStep® Technology enables the OS to control and activate performance states (P-States) of the processor.

[Enabled] When enabled, Intel SpeedStep® technology is activated. This technology allows the processor to manage its power consumption via performance state (P-State) transitions.

[Disabled] Disables this function.

## ► Intel(R) Speed Shift Technology

Intel® Speed Shift Technology is an energy-efficient method that allows frequency control by hardware rather than the OS.

[Enabled] When enabled, Intel® Speed Shift Technology is activated. The technology enables the management of processor power consumption via hardware performance state (P-State) transitions.

[Disabled] Disable this function.

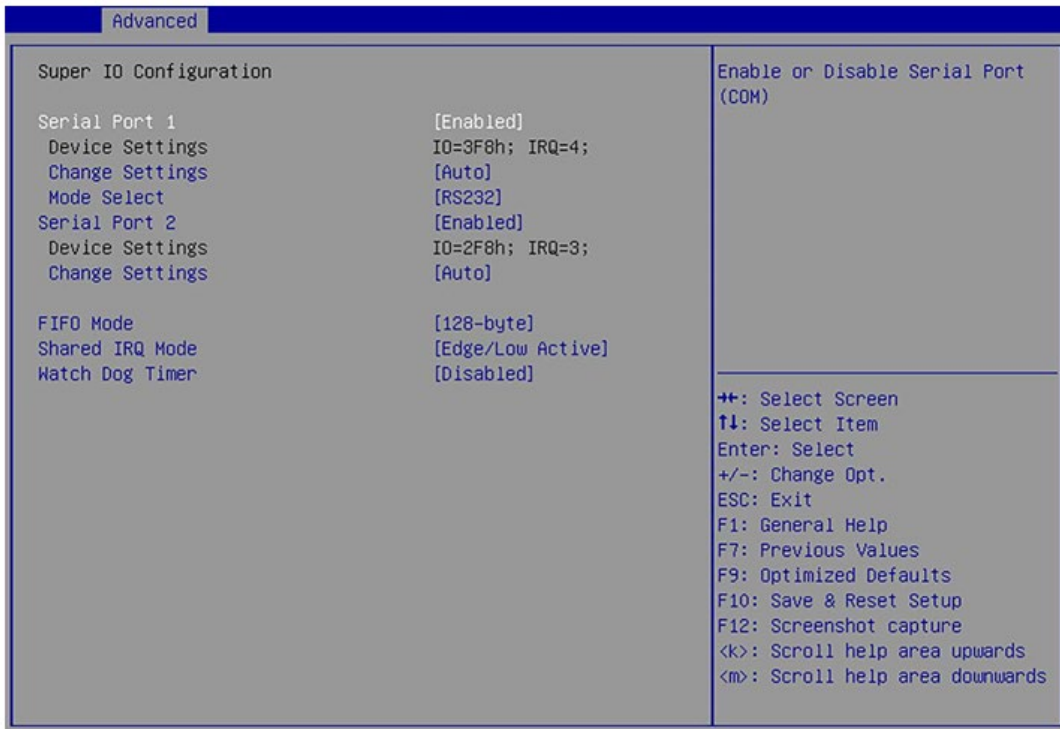
## ► C States

This setting controls the C-States (CPU Power states).

[Enabled] Detects the idle state of system and reduce CPU power consumption accordingly.

[Disabled] Disable this function.

## ► Super IO Configuration



### ► Serial Port 1/2

This setting enables or disables the specified serial port.

#### » Change Settings

This setting is used to change the address & IRQ settings of the specified serial port.

#### » Mode Select

Select an operation mode for Serial Port 1/2.

### ► FIFO Mode

This setting controls the FIFO (First In First Out) data transfer mode.

### ► Shared IRQ Mode

This setting provides the system with the ability to share interrupts among its serial ports.

### ► Watch Dog Timer

You can enable the system watchdog timer, a hardware timer that generates a reset when the software that it monitors does not respond as expected each time the watchdog polls it.

## ► H/W Monitor (PC Health Status)

These items display the current status of all monitored hardware devices/ components such as voltages, temperatures and all fans' speeds.

Advanced	
Pc Health Status	
Thermal Shutdown	[Disabled]
CPU temperature	: +33 C
System temperature	: +43 C
SYSFAN	: N/A
VCC_CORE	: +0.752 V
VCC3	: +3.312 V
VCC5	: +5.171 V
+12V	: +12.144 V
VSB3V	: +3.312 V
VSB5V	: +5.016 V
VBAT	: +3.072 V
Thermal Shutdown ++: Select Screen ↑↓: Select Item Enter: Select +/-: Change Opt. ESC: Exit F1: General Help F7: Previous Values F9: Optimized Defaults F10: Save & Reset Setup F12: Screenshot capture <k>: Scroll help area upwards <m>: Scroll help area downwards	

### ► Thermal Shutdown

This setting determines the behavior of the system when the CPU temperature reaches a predefined threshold.

[Enabled] Initiate an automatic shutdown of the system to protect from potential damage due to overheating.

[Disabled] Disable this function.

## ► Smart Fan Configuration

Advanced	
Configuration Smart FAN	
SYSFAN	[Disabled]
Disabled/Enabled Smart FAN Function	

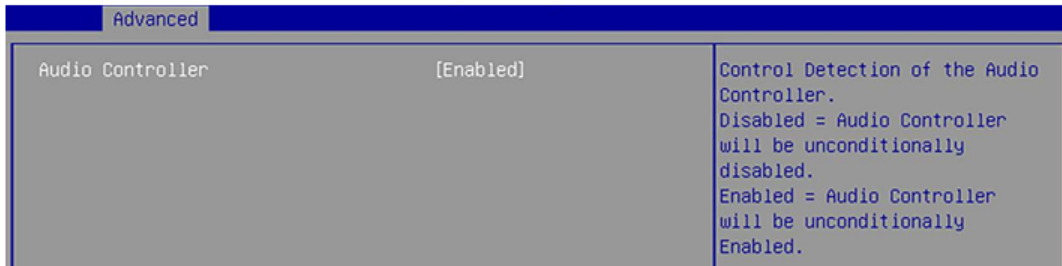
### ► SYSFAN

This setting enables or disables the Smart Fan function. Smart Fan is an excellent feature which will adjust the system fan speed automatically depending on the current system temperature, avoiding the overheating to damage your system. The following items will display when **SYSFAN** is enabled.

#### » Min. Speed (%)

The beginning speed of the System fan.

## ► PCI/PCIE Device Configuration

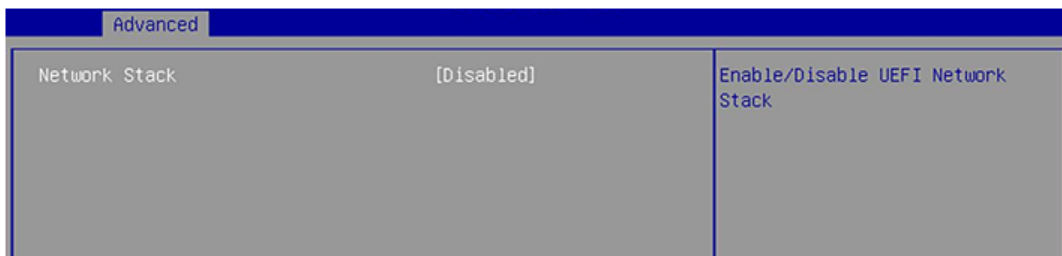


### ► Audio Controller

This setting enables or disables the detection of the onboard audio controller.

## ► Network Stack Configuration

This menu provides Network Stack settings for users to enable network boot (PXE) from BIOS.



### ► Network Stack

This menu provides Network Stack settings for users to enable network boot (PXE) from BIOS. The following items will display when **Network Stack** is enabled.

#### » IPV4 PXE Support

Enables or disables IPv4 PXE boot support.

#### » IPV4 HTTP Support

Enables or disables Ipv4 HTTP Support.

#### » IPV6 PXE Support

Enables or disables Ipv6 PXE Support.

#### » IPV6 HTTP Support

Enables or disables Ipv6 HTTP Support.

#### » PXE boot wait time

Use this option to specify the wait time to press the ESC key to abort the PXE boot. Press "+" or "-" on your keyboard to change the value. The default setting is 0.

#### » Media detect count

Use this option to specify the number of times media will be checked. Press "+" or "-" on your keyboard to change the value. The default setting is 1.

## ► GPIO Group Configuration

Advanced		
GP00	[Low]	Set GP00 to output High/Low
GP01	[Low]	
GP02	[Low]	
GP03	[Low]	

### ► GP00 ~ GP03

These settings control the operation mode of the specified GPIO.

## ► PCIE ASPM settings

This menu provide settings for PCIe ASPM (Active State Power Management) level for different installed devices.

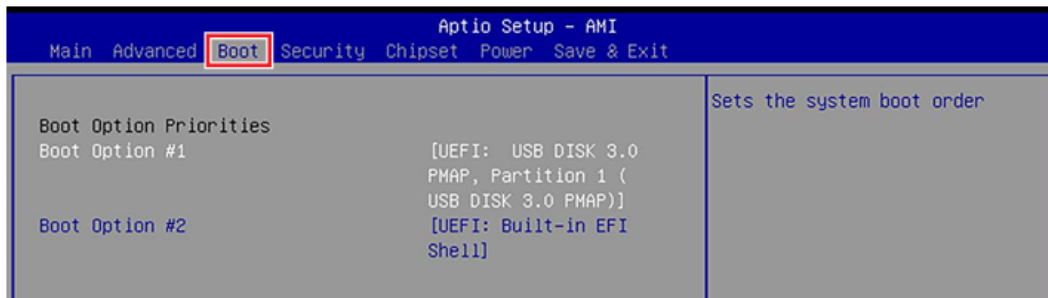
Advanced		
M2_B1	[Disabled]	Set the ASPM Level: Force L0s - Force all links to L0s State AUTO - BIOS auto configure DISABLE - Disables ASPM
M2_E1	[Disabled]	

### ► M2\_B1/ M2\_E1

Sets PCI Express ASPM (Active State Power Management) state for power saving.

- [L0s]            Initiate an automatic shutdown of the system to protect from potential damage due to overheating.
- [L1]            Higher latency, lower power “standby” state **(optional)**.
- [L0sL1]        Activate both L0s and L1 support.
- [Disabled]     Disable this function.

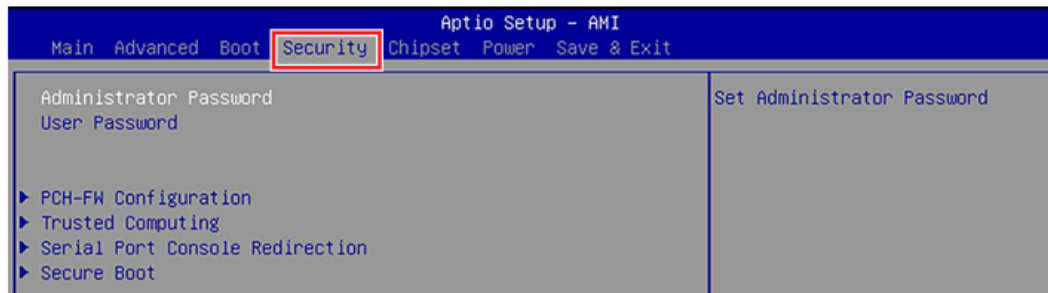
## 3.2.3 Boot



### ► Boot Option #1-2

This setting allows users to set the sequence of boot devices where BIOS attempts to load the disk operating system.

## 3.2.4 Security



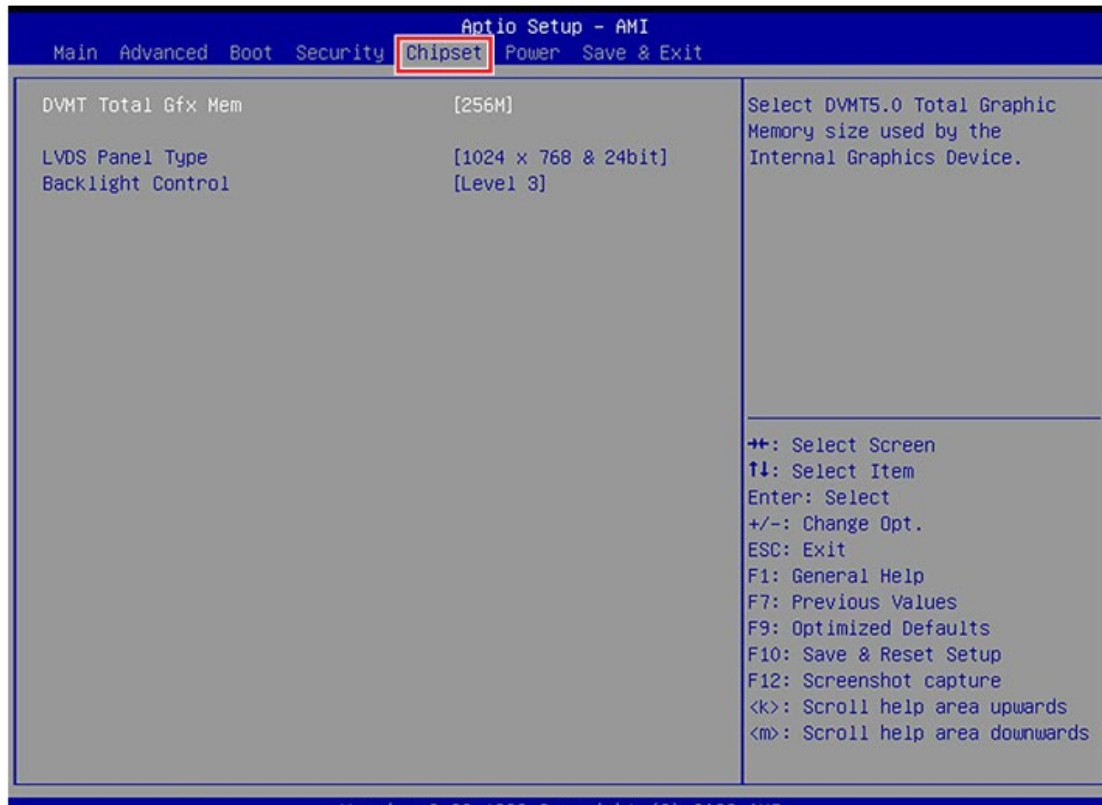
### ► Administrator Password

Administrator Password controls access to the BIOS Setup utility.

### ► User Password

User Password controls access to the system at boot and to the BIOS Setup utility.

## 3.2.5 Chipset



### ► DVMT Total Gfx Mem

This setting specifies the total graphics memory size for Dynamic Video Memory Technology (DVMT).

### ► LVDS Panel Type

This setting specifies the LVDS Panel's resolution and distribution formats.

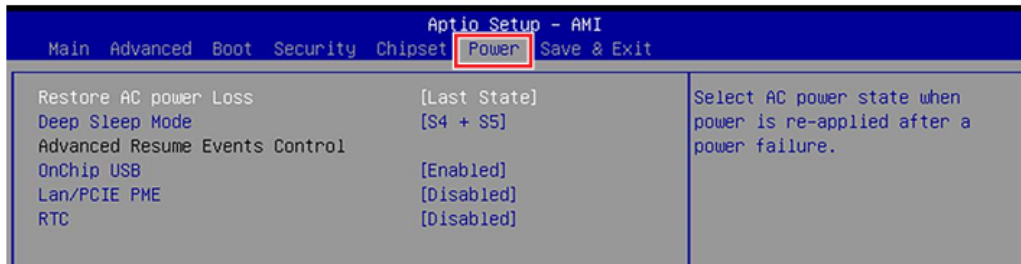
### ► Backlight Control

This setting controls the intensity of the LED's backlight output. When lighting conditions are brighter, set it high for a clearer image and low when it is darker.

LED's backlight output	
[Level 1]	20%
[Level 2]	40%
[Level 3]	60%
[Level 4]	80%
[Level 5]	100%



## 3.2.6 Power



### ► Restore AC Power Loss

This setting specifies whether your system will reboot after a power failure or interrupt occurs. Available settings are:

- [Power Off] Leaves the computer in the power off state.
- [Power On] Leaves the computer in the power on state.
- [Last State] Restores the system to the previous status before power failure or interrupt occurred.

### ► Deep Sleep Mode

The setting enables or disables the Deep S5 power saving mode. S5 is almost the same as G3 Mechanical Off, except that the PSU still supplies power, at a minimum, to the power button to allow return to S0. A full reboot is required. No previous content is retained. Other components may remain powered so the computer can "wake" on input from the keyboard, clock, modem, LAN, or USB device.

### ► OnChip USB

The item allows the activity of the OnChip USB device to wake up the system from S4/ S5 sleep state.

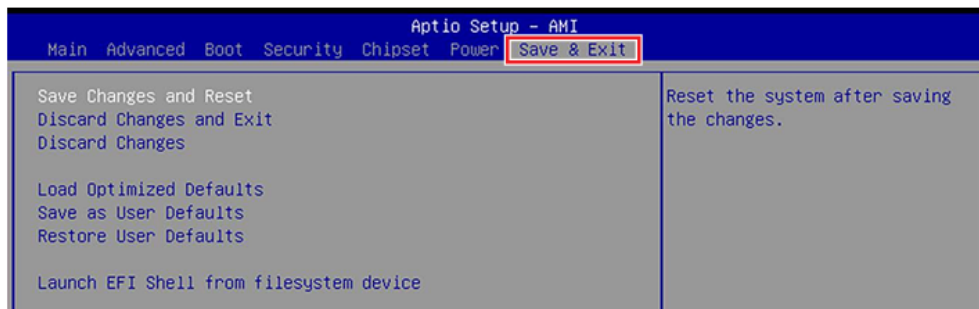
### ► LAN/ PCIE PME

Enables or disables the system to be awakened from the power saving modes when activity or input signal of Intel LAN device and onboard PCIE PME is detected.

### ► RTC

When [Enabled], you can set the date and time at which the RTC (real-time clock) alarm awakens the system from suspend mode.

## 3.2.7 Save & Exit



### ▶ Save Changes and Reset

Save changes to CMOS and reset the system.

### ▶ Discard Changes and Exit

Abandon all changes and exit the Setup Utility.

### ▶ Discard Changes

Abandon all changes.

### ▶ Load Optimized Defaults

Use this menu to load the default values set by the motherboard manufacturer specifically for optimal performance of the motherboard.

### ▶ Save as User Defaults

Save changes as the user's default profile.

### ▶ Restore User Defaults

Restore the user's default profile.

### ▶ Launch EFI Shell from filesystem device

This setting helps to launch the EFI Shell application from one of the available file system devices.